

Industrial Bench and Floor Scales

For reliable weighing throughout the process chain



Our portfolio of industrial bench and floor scales offers a variety of solutions for a raft of industrial requirements and applications. The highest levels of precision and dependable German Quality guarantee consistently reliable measurements from the moment goods arrive at customers' premises to the moment they leave.

The true measure

Minebea Intec is a leading manufacturer of industrial weighing and inspection technologies. Our mission is to increase the reliability, safety and efficiency of our customers' production processes. To do this, we provide high-quality products, solutions and services that ensure a high level of safety.

Minebea Intec's excellent performance is based on 150 years of experience, our distinct German Quality and continuous investments in the development of innovative technologies. Our strong global presence and an extensive network of distribution partners ensure that our customers can rely on top Minebea Intec quality – any time, anywhere. Our goal is to set strong standards in all areas of our company, which is reflected in our brand slogan, 'the true measure'.

By purchasing Minebea Intec products, every day, customers all over the world are choosing more than just innovative technologies: they are also choosing top-quality service performance and comprehensive support throughout the entire life cycle of their product. Our aim is to fulfil our customers' requirements no matter what the industry, and to be the first port of call for weighing and inspection technologies. In short: the best expert you could have!

Products and solutions from Minebea Intec are firmly established in many sectors





- Minebea Intec Sales - Service
- Minebea Intec Production - Sales - Service
- Distribution Partners (size refers to amount of Partners)
 - up to 5
 - up to 20
 - above 20

The MinebeaMitsumi group

The MinebeaMitsumi group is a global precision electromechanical components manufacturer, providing products for various industries. Minebea was founded in 1951 in Japan, Mitsumi in 1954. The company currently employs around 80,000 people and has more than 120 production sites and sales and service locations around the world. For many products, the MinebeaMitsumi group is No. 1 in terms of its global market share.

As varied as our customers' requirements

Minebea Intec provides innovative products and solutions for reliable weighing throughout the process chain. Our comprehensive range of industrial bench and floor scales, along with individual components and accessories, allows weighing solutions to be configured to the exact usage profile of a given application, from loads of 0.001 g to 3,000 kg, from conformity assessments to hygiene, right thorough to EX certification. The result: the most accurate, reliable measurements at any time and with the ability to meet any requirement.

For example:

- Weight checks and integrity checking
- Classification, sorting and counting by weight
- Filling and formulation in recipe management
- Checking inventories, production volumes and outgoing goods
- Commissioning for shipping
- Statistical checking of production processes



Discover the right industrial scale for your process.
You can download our **White Paper** here!

Always the right solution for each of these applications:



Why Minebea Intec?

Minebea Intec is a byword for quality and cutting-edge technology. Our innovative German Quality solutions have proved themselves all over the world, handling the very toughest of conditions and the strictest of requirements. We offer on-site support and services throughout the entire life cycle of our products. This means our customers always have the best possible solution for their requirements.



German Quality



'The industrial scales from Minebea Intec make an important contribution to the quality of a product. Their precise measurements reduce production rejection, which in turn makes us more profitable.'

Industrial bench and floor scales

Minebea Intec has decades of experience in the industrial scales sector. Our proven German Quality scales are robust and highly accurate, and they have exceptionally short weighing times. This means they don't just help our customers to make their processes faster and more accurate – all our industrial scales also ensure accurate, stable and reproducible measurements over the long term.

Quality is our best product

Our aim is to deliver products of premium quality to our customers. One way we do this is by checking our quality standards regularly and thoroughly. As part of the final completion process, every device goes through a comprehensive and detailed testing programme. Internal product audits are also carried out regularly. Management systems at all Minebea Intec facilities meet the requirements of DIN EN ISO 9001 at the very least, and are part of our company policy.

Adjustment, calibration and conformity assessment

Many of Minebea Intec's industrial scales are equipped with a built-in motorised calibration weight. This allows the scales' accuracy to be checked at the touch of a button without the need for an additional test weight. The sensitivity of the scales can also be easily calibrated by touching a button. To ensure that legal requirements are complied with and that weighing results are traceable, we can also provide calibration and conformity assessments (previously verification) of scales during servicing. Our expertise in this area is backed up by the following certificates and accreditations:

- Certificate of recognition for a quality management system according to 2014/31/EU for non-automatic scales
- DAkkS (German national accrediting body) accreditation for calibration of non-automatic scales according to DIN EN/ISO/IEC 17025
- DAkkS (German national accrediting body) accreditation for calibration of weights from 1 mg to 1,000 kg according to DIN EN/ISO/IEC 17025
- Certified QM system according to DIN ISO 9001

Just ask us! We are happy to advise you on our country-specific approvals



Bench and floor scale Combics®

The bench and floor scale Combics® combines precision and versatility. All platforms are equipped with proven precision strain-gauge technology, and some models have high-resolution electromechanical force compensation. The modular design allows for maximum flexibility to install the indicator and platform separately as well as targeted replacement of individual components. Choose between:

- Three easy-to-use indicators for various requirements
- A variety of finishes, e.g. stainless steel
- Load ranges of between 3 kg and 3 t
- Readability from 0.05 g to 200 g
- Platforms in various designs and sizes
- A range of resolutions from 3,000 d to 340,000 d
- Verification mode and explosion-proof solutions
- An extensive range of accessories, options and add-ons



Floor scale Combics®



Indicator Combics® 1



Indicator Combics® 2



Indicator Combics® 3



Explosion protection

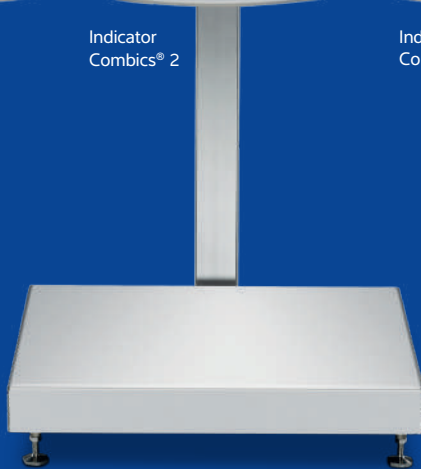

Bench scale Combics®

Smart software applications

- Easy-to-use application software for a variety of uses, such as counting, checking and pre-packaging checking, is pre-installed as a standard feature

Versatile interfaces

- Optimal connectivity and integration into existing systems, for example via RS 232, RS 485/422, analogue 4–20 mA, digital inputs/outputs, Profibus DP, Ethernet TCP/IP

Particularly suited for uses such as:

- Statistical recording of weights, connection to SPC@Enterprise
- Automatic and manual dosing and filling
- Manual dispensing, production of mixtures
- Totalling and picking of orders
- Classing, classification and sorting by weight
- Part counts for materials management
- Simple recording of weights with logs for documentation
- Checking, for example when checking contents of pre-packaged units
- Weighing containers and vessels for storage management

Bench scale Signum®

The bench scale Signum® has been specifically developed as a compact solution for a variety of industries. All scales in the range are based on strain-gauge (SG) or electromagnetic force compensation (EMFC) technology. Within everyday weighing applications, they stand out thanks to their short measurement times, flexibility and safety. The indicator can be set up according to the use regardless of location of the platform and can even be mounted on a stand. Our customers can choose between models with Supreme, Advanced or Regular specifications, depending on the level of precision required. They can also choose from:

- Three easy-to-use indicators with varying usage levels
- IP43 or IP65 protection classes
- A variety of finishes, e.g. stainless steel
- Load ranges of between 0.6 kg and 65 kg
- Readability from 0.001 g to 10 g
- Platforms in various designs and sizes
- Verification mode and explosion-proof solutions
- A wide range of interfaces
- An extensive range of accessories, options and add-ons



Particularly suited for uses such as:

- Automatic and manual dosing and filling
- Manual dispensing, production of mixtures
- Totalling and picking of orders
- Classing, classification and sorting by weight
- Part counts for materials management
- Simple recording of weights with logs for documentation
- Checking, for example when checking contents of pre-packaged units
- Weighing containers and vessels for storage management

Supreme, Advanced or Regular?

The bench scale Signum® is available in a range of resolutions depending on the level of precision required:

Signum® Regular

- Standard SG weighing system
- High level of built-in overload protection
- Resolution up to 35,000 d

Signum® Advanced

- Mechatronic SG weighing system
- Both high-resolution and economical thanks to added electronic compensation
- Resolutions up to 80,000 d or 150,000 d

Signum® Supreme

- Monolithic EMFC weighing system
- Precise measurements that minimise product loss and increase profitability
- Precise measurements at all times thanks to the built-in motorised calibration weight
- Resolutions up to 350,000 d or 620,000 d



Bench scale Signum®

Bench and floor scale Midrics®

The bench and floor scale Midrics® is durable, has a long product lifetime and is easy to clean. The indicator can be set up according to the use regardless of location of the platform and can even be mounted on a stand. Choose between:

- Diverse selection of indicators and platforms
- IP65 or IP67/IP68 protection classes
- Load ranges of between 3 kg and 3 t
- Readability from 0.2 g to 200 g
- Verification mode
- A range of resolutions from 3,000 d to 15,000 d
- A wide range of interfaces
- An extensive range of accessories, options and add-ons



Bench scale Midrics®

Industrial scale Puro®

Scales from the Puro® series have been developed for a wide range of weighing requirements. Whether it's for weighing, counting or quality control – all Puro® scales stand out due to their speed and precision. Their durable design and innovative and user-friendly applications make Puro® scales the perfect choice in all areas of industrial weighing.

Puro® makes excellent weighing technology affordable

Customers choose the right Puro® for their needs from a comprehensive portfolio. They are delivered in the shortest possible time via one of our global distribution hubs.

- **Compact scales**
With large, bright displays and a traffic light system for highly convenient operation
- **Weight indicator**
Reliable, precise weighing results in an instant
- **Bench and floor scales**
In many different dimensions, capacities, resolutions and designs depending on requirements
- **Bench and floor scale platforms**
Durable solutions for a wide range of requirements



Particularly suited for uses such as:

- Manual dosing and filling
- Manual dispensing, production of mixtures
- Totalling and picking of orders
- Part counts for materials management
- Classing, classification and sorting by weight
- Simple recording of weights with logs for documentation
- Checking, for example when checking contents of pre-packaged units
- Weighing containers and vessels for storage management

That is Puro®



Puro® was developed under the premise of transforming our proven quality standards and leading technologies into a diverse and affordable series of industrial scales.

Our development efforts have resulted in innovative weighing solutions that are intuitive to use and offer unique features on the market.

Our aim is to always provide a perfect industrial scale – for any requirement, anywhere and in the shortest possible time.

In this sense, one important function already comes pre-installed in every Puro®: customer focus.

Special performance features

- Exceptional user convenience
- Intelligent, well-engineered and affordable product portfolio
- Up to 200 hours of battery life.
Up to 500 hours with optional battery pack
- First industrial scale that can be recharged via a USB-C connection as standard
- Wireless operation with optional Bluetooth or WiFi connectivity
- Global delivery within a few days
- Reliable after-sales service with fast reaction times

New!



Minebea
Intec

Industrial floor scales

Industrial floor scales are characterised by extremely large platforms and are suitable for all sectors in which heavy and bulky loads have to be weighed. In the shape of the floor scales Combics® and Midrics®, along with the flat-bed scale IF and the pallet scale IU, Minebea Intec offers a raft of weighing solutions – including for potentially explosive environments.

Flat-bed scale IF

The flat-bed scale IF has been developed for the maximum possible ground-level use in the smallest possible space. It is a high-quality, flexible and mobile weighing station, which can be used anywhere in the production process where reliable measurements and hygienic solutions are required. Its benefits and options are:

- Custom specifications available on request
- A variety of finishes, e.g. stainless steel
- Verification mode and explosion-proof solutions
- IP65, IP68 or IP69 protection classes
- Resolution up to 30,000 d and up to 2 x 3,000 e in situations where verification is required
- Load ranges of between 150 kg and 3,000 kg
- Platforms in various designs and sizes



Explosion protection



Hygienic Design



IF flat-bed scale

Why a flat-bed scale from Minebea Intec?

- Ergonomic design for easy handling
- Hygienic Design, e.g. for use in clean rooms
- Tough and robust for use with aggressive substances
- Easy dry and wet cleaning
- Rollers and steering drawbar for mobility
- Reliable construction guaranteeing low maintenance costs and a long service life



Various designs and options for customised solutions

Standard flat-bed scale IF

Low platform height and very short ramp with minimal incline to save on space. Available with drive-through protection, additional transport handles and rollers, among other options.

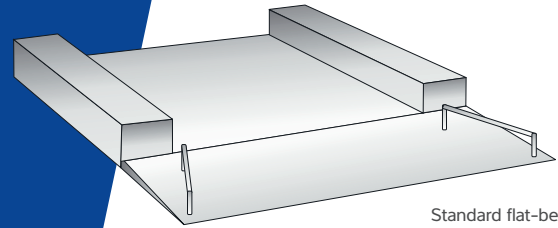

Standard flat-bed scale IF

Flat-bed scale IF with pneumatic lift mechanism

Ideal for stationary use. For complete cleaning of the scale and floor, the platform is just folded up. Available with a second ramp or as a weighing solution for operation by one person, among other options.

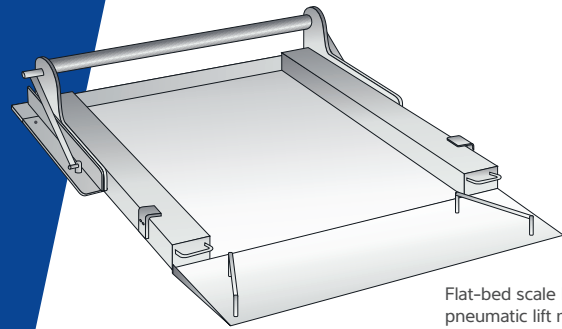

Flat-bed scale IF with pneumatic lift mechanism

Flat-bed scale IF with rollers

The version with retractable rollers can be pushed by one person, making it ideal for use in a number of different locations and for easy floor cleaning. Available with retractable rollers or steering drawbar and drive-through protection, among other options.

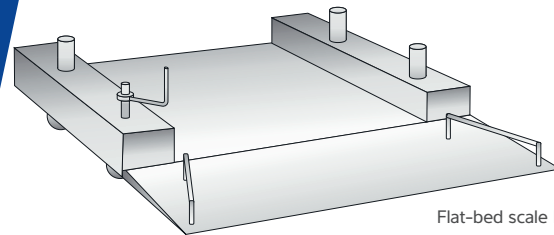

Flat-bed scale IF with wheels



Pallet scale IU

The pallet scale IU comes in 48 basic models, allowing us to offer an individual weighing solution for the widest possible range of industry requirements at any time. The range is rounded off by a comprehensive choice of additional options:

- A variety of finishes, e.g. stainless steel
- Explosion-proof solutions
- IP65 or IP68 protection classes
- Resolution from 15,000 d to 30,000 d, 1 x 3,000 e and 2 x 3,000 e
- Load ranges of between 300 kg and 3,000 kg
- Sheet inserts and additional stands available on request
- Custom specifications available on request



Explosion protection



Hygienic Design

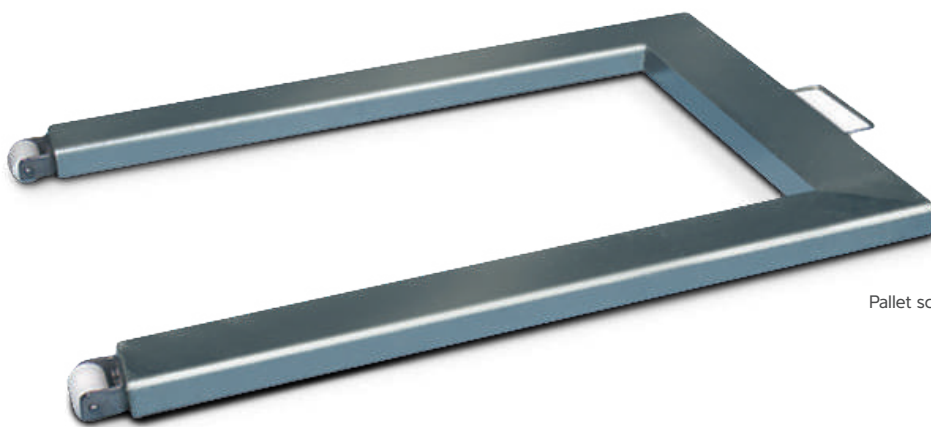

Pallet scale IU

Why a pallet scale from Minebea Intec?

- Easy handling
- Hygienic design
- Tough and robust for use with aggressive substances
- Rollers for mobility
- Reliable construction guaranteeing low maintenance costs and a long service life

Explosion-proof solutions

For devices to be used safely in potentially explosive environments, their safety levels have to be compatible with local safety requirements. As a reliable partner for industry, Minebea Intec holds international approvals such as IECEx, ATEX, NEC, CEC and NEPSI, as well as a comprehensive range of industrial bench and floor scales for potentially explosive environments. All scales can be used as explosion-proof solutions in EX zones 1 and 21.



Please don't hesitate to get in touch with us! We will be happy to advise you on our explosion-proof solutions, how they can be used and any country-specific approvals.

sales.industry@minebea-intec.com

The following bench and floor scales are available in an explosion-proof version:



Explosion protection

Bench and floor scales Combics®

Precision, variety and a modular design for maximum flexibility. Indicators and platforms available as explosion-proof solutions.



Bench scale Combics®

Bench scale Signum® Supreme

The compact solution for a variety of industries, with EMFC technology guaranteeing maximum precision. Platform available as an explosion-proof solution.

Economy bench and floor scale

The tough complete scale for reliable quality control.

Flat-bed scale IF

The high-quality, flexible and mobile weighing station for heavy and bulky loads.



Flat-bed scale IF

Pallet scale IU

Reliable and versatile pallet weighing.

Configuration options

Platforms

A range of platforms are available depending on the size, weight and environment of the goods and products to be weighed. Together with the indicators, they form an optimal solution for almost every weighing task and use.

A variety of finishes

From stainless steel to powder-coated and galvanised

Load ranges

From 0.6 kg to 3,000 kg

Overall platform size

From 320 mm to 2,000 mm

Readability

From 0.001 g to 1,000 g

Verification capability/explosion-proof solution

Range of accuracy classes/various EX zones



Weighing platform Combics®



Weighing platform IS



Weighing platform Combics®

Accessories/add-ons



For more detailed information, please visit our website or contact
sales.industry@minebea-intec.com

Indicators

A range of indicators are available depending on the resolution, verification capability and use (displays and control panels). Their benefits are:

- **Smart software applications**
Easy-to-use application software programmes for a variety of uses, such as counting, checking and pre-packaging checking, are pre-installed as a standard feature
- **Versatile interfaces**
Optimal connectivity and integration into existing systems, for example via RS 232, RS 485/422, analogue 4–20 mA, digital inputs/outputs, Profibus DP, Ethernet TCP/IP

Indicator Combics® 1

For simple weighing solutions

- 14-segment display



Indicator Combics® 1

Indicator Combics® 2

For demanding weighing solutions

- 14-segment display
- High-contrast LCD display with backlight
- Also available as an explosion-proof solution



Explosion protection



Indicator Combics® 2

Indicator Combics® 3

For complex weighing solutions

- High-contrast graphic display with backlight
- Softkey-supported application packages
- Traffic light system for checking purposes



Indicator Combics® 3

Indicators Midrics®

- Midrics 1 for simple weighing solutions, with backlit LCD display
- Midrics 2 for complex weighing solutions, with backlit LCD display, numerical keyboard and comprehensive application software



Indicator Midrics® 2

Accessories, options and add-ons

All accessories and add-ons for our range of bench and floor scales have been developed with a particular focus on the needs of our customers and they have proven themselves countless times across a wide variety of industries.

Industrial printers

Several compact, high-performance industrial printers are available for a variety of uses. Their benefits and options are:

- Fast and reliable printing of process, product and weighing data
- Simple and intuitive installation and operation
- Robust, space-saving product design
- Process reliability and quality through comprehensive print data management
- A variety of printing modes, including direct thermal, thermal transfer and 9-dot matrix



Industrial printer
YDP 21



Industrial printer
ZD420

Bar code reader

- Optical and acoustic response when reading bar codes
- Processes a wide variety of bar code types measuring up to 120 mm in width
- Green LED for user response

Floor-mounted and bench stands

- A variety of finishes
- A variety of heights to support a wide range of uses

Frame for pit installation

- A variety of finishes
- Available with installation kit

Ramps

- Variety of models
- Installation kit included

Software

Innovate software programmes are available for the reliable integration of our bench and floor scales into production lines. They are continually being updated and expanded. For our service customers, these updates are automatically included according to their agreement level.

Software SPC@Enterprise

The high-performance software for statistical process control now boasts even more benefits:

- Efficient networking of a diverse range of devices and systems from Minebea Intec and other vendors
- Fast process control thanks to powerful monitoring programme
- Straightforward generation of production or calibration statistics
- Simple data backup, less risk of data loss



Software SPC@Enterprise

Software ProRecipe XT®

Intelligent recipe management guarantees reliable processes in a variety of industries.

- For intuitive control and monitoring of recipe processes
- Flexible integration into production systems
- Guaranteed traceable product quality
- Meets the validation requirements of the pharma industry



Software ProRecipe XT®

Our product portfolio



Acceptance and storage of loose materials

Incoming goods

Acceptance of piece goods

Automated production systems

Reliable checking of supplied and stored materials

For complete process control



Components and solutions for vehicle weighing (analogue/digital)



Components and solutions for silo weighing



Batching and formulation



Foreign object detection (metal detection/X-ray inspection)



Weighing of incoming goods



Components and solutions for vessel weighing (analogue/digital)

This is a cross-section of our extensive product portfolio. We offer tailor-made solutions for a range of requirements: from simple to complex; from explosion protection solutions to hygienic design.

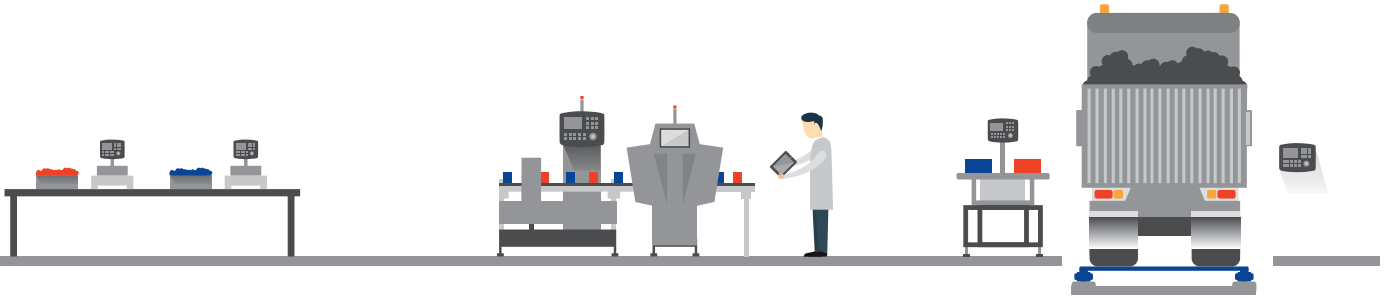

Manual production

Solutions that ensure accuracy and traceability



Portioning and checkweighing



Formulation and formulation weighing

Packaging

Guaranteeing product quality and food safety



Checkweighing/metal detection



X-ray inspection



Pre-packaging checking and statistical process control

Outgoing goods

Quality assurance of final product



Weighing/order picking of outgoing goods



Checkweighers for heavy loads



Components and solutions for vehicle weighing (analogue/digital)

Our services

Via our world-wide presence, we and our certified partners stand beside our customers across the globe throughout the entire life cycle of our products and solutions, from choosing the right equipment and systems to upgrades, replacement parts and training.

Engineering Support and Global Solutions – ensuring optimal solutions

- Consultation on selecting the best products and solutions with regard to the desired performance, precision and costs
- Design-in support for the integration of our products and solutions in existing constructions
- Customer-specific products or solutions – tailored to individual requirements



For more detailed information, please visit our website or contact info@minebea-intec.com



engineering support
by Minebea Intec



Commissioning – for a timely start to production

- Mechanical and/or electrical installation, commissioning and training on set-up and use
- Calibration or conformity assessment of equipment and systems according to statutory requirements for measuring technology
- Equipment qualification (IQ/OQ)

Upgrades – to update systems and improve performance

- Hardware and software upgrades
- Equipment refurbishment

Training courses – to improve skills

- Practical training content that reduces operating errors, downtime and maintenance costs and therefore increases the performance of the equipment and the efficiency of the line
- Seminars providing knowledge of regulations and technologies

academy
by Minebea Intec



Maintenance and repair – for guaranteed availability and performance

- Calibration or verification preparation of equipment and systems according to statutory requirements for measuring technology
- Preventative maintenance safeguarding continued availability and performance
- Repair services, including emergency service contracts for a guaranteed response time
- Professional replacement parts service
- Remote services such as the service tool miRemote based on augmented reality – for first-line support on site

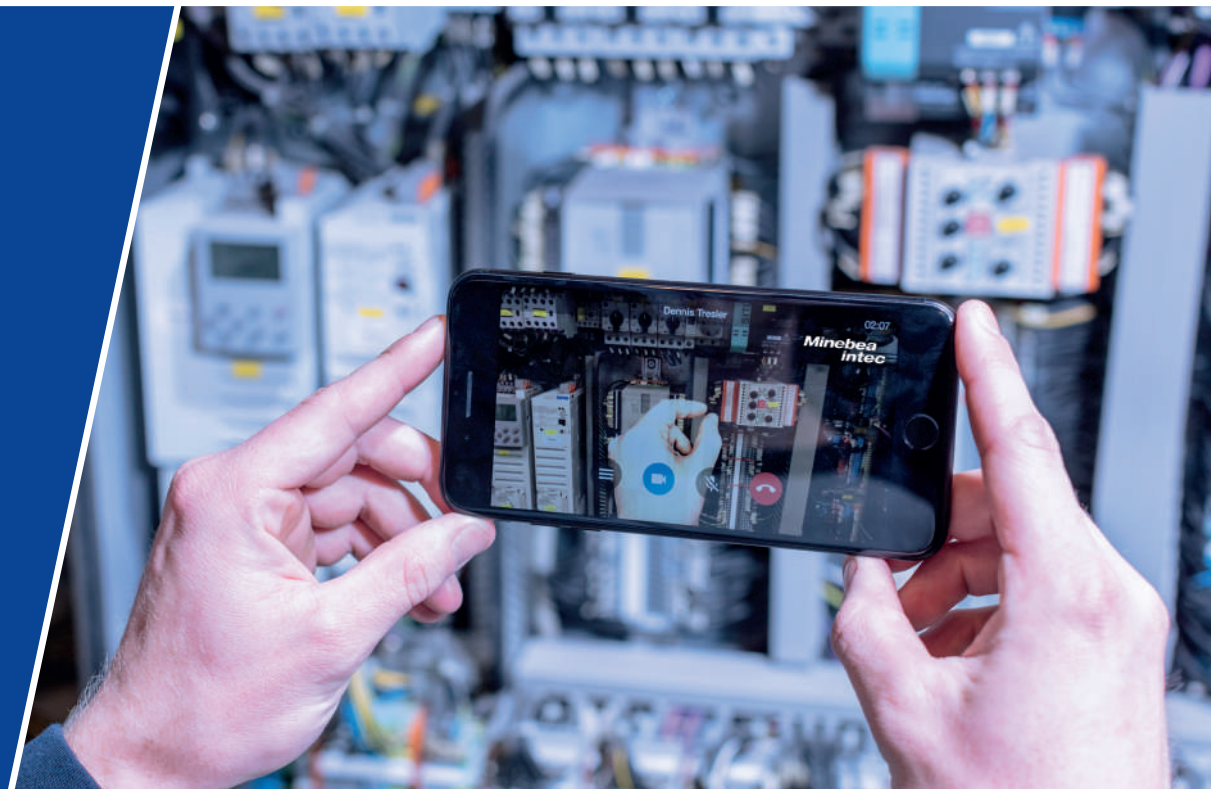

Everything from a single source

Minebea Intec provides products, solutions and services to improve the reliability, safety and efficiency of production and packaging lines in virtually all industries.

From goods receipt to goods issue – our portfolio comprises a variety of automatic and manual weighing and inspection solutions, software and services for a wide range of applications and industries.

Process weighing and automation

- Vessel and silo scales
- Components for truck scales
- Bench and floor scales
- Batching and formulation

Quality assurance

- Checkweighers
- Metal detectors
- X-ray inspection systems
- Statistical process control

Services

- Technical support
- Commissioning
- Maintenance and repair
- Upgrades
- Training courses



Minebea Intec Bovenden GmbH & Co. KG

Leinetal 2, 37120 Bovenden, Germany

Phone +49.55 1.309.83.0

Email sales.industry@minebea-intec.com

www.minebea-intec.com



Minebea
intec
The true measure